

OUR MOST COMPACT HOME LIFT

Aritco 4000 Datasheet 2020

The lift has been designed to meet all requirements for comfort, space and design. The lift is available in different sizes, with an option to personalise it with details such as glass walls, a range of varied colours and different materials.

Several advantages offered by Aritco 4000:

- Design, sizes and options created for a home environment
- Minimum interventions in the house
- 'A' rated energy consumption according to VDI4707
- 95% recyclable materials
- Patented screw/nut technology (no oil that can leak)
- The lowest maintenance and operating costs on the market

For more information please visit www.access-solutions.com.au

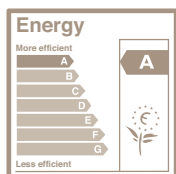

ARITCO™

DISTRIBUTOR

Aritco Lift AB
Elektronikhöjden 14, Box 516
175 26 Järfälla, Sweden

ACCESS
Solutions

ARITCO 4000

LIFT COLOUR

Can be painted in any RAL colour from the Chart K7 classic chart (except for pearl and fluorescent colours).

FLOOR

9 different floorings to choose from.



GLASS

4 different glass types to choose from.



DOORS

2 different door types to choose from.

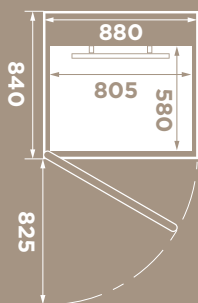

Size: 580 x 805 mm
Rated load: 250 kg / 2 persons

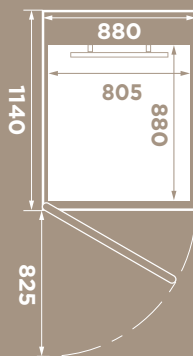



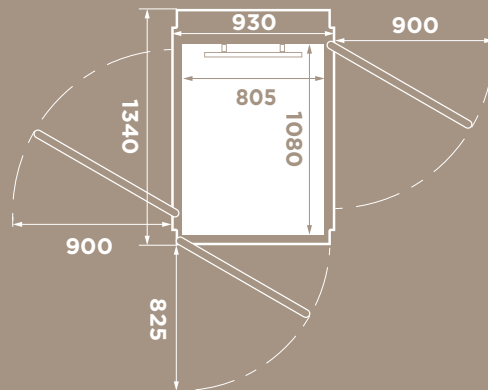



Size: 880 x 805 mm
Rated load: 250 kg / 2 persons

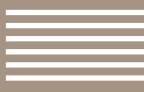

Size: 1080 x 805 mm
Rated load: 250 kg / 2 persons

Product summary

<p>TOP HEIGHT</p> <p>2300 mm</p>	<p>TYPE OF LIFT Home lift intended for installation in private homes. Only to be used in buildings without public access.</p>	<p> RATED SPEED Max 0,15 m/s</p>	<p> DRIVE SYSTEM Patented screw and nut system 1.5 kW motor</p>	<p>CONTROL FROM CARRIER CONTROL PANEL Hold to run - press and hold For installations outside Europe - One touch operation (press one time)</p>	<p>NUMBER OF FLOORS</p> <p> 2 to 6 floors</p>
<p> INSTALLATION Recessed installation 50 mm below floor Installed directly on the floor with 50 mm ramp</p>	<p>INDOOR INSTALLATION ENVIRONMENT</p>	<p>TRAVEL HEIGHT 250-13 000 millimeter</p>	<p> WARRANTY Aritco 4000 comes with a 24 month warranty. The screw and nut assembly has a 10 year warranty.</p>	<p> TECHNICAL COMPLIANCE European Machine directive 2006/42/EC European standard EN 81-41</p>	
<p> Power supply 230 V 1-phase</p>	<p><i>Emergency lowering:</i> Battery-powered</p>				